

LCD Splicing Display Unit

User Manual

Disclaimer and Safety Warnings

Copyright Statement

©2024 Zhejiang Uniview Technologies Co., Ltd. All rights reserved.

No part of this manual may be copied, reproduced, translated or distributed in any form or by any means without prior consent in writing from Zhejiang Uniview Technologies Co., Ltd (referred to as Uniview or us hereafter). The product described in this manual may contain proprietary software owned by Uniview and its possible licensors. Unless permitted by Uniview and its licensors, no one is allowed to copy, distribute, modify, abstract, decompile, disassemble, decrypt, reverse engineer, rent, transfer, or sublicense the software in any form or by any means.

Trademark Acknowledgements

 are trademarks or registered trademarks of Uniview.

All other trademarks, products, services and companies in this manual or the product described in this manual are the property of their respective owners.

Export Compliance Statement

Uniview complies with applicable export control laws and regulations worldwide, including that of the People's Republic of China and the United States, and abides by relevant regulations relating to the export, re-export and transfer of hardware, software and technology. Regarding the product described in this manual, Uniview asks you to fully understand and strictly abide by the applicable export laws and regulations worldwide.

Privacy Protection Reminder

Uniview complies with appropriate privacy protection laws and is committed to protecting user privacy. You may want to read our full privacy policy at our website and get to know the ways we process your personal information. Please be aware, using the product described in this manual may involve the collection of personal information such as face, fingerprint, license plate number, email, phone number, GPS. Please abide by your local laws and regulations while using the product.

About This Manual

- This manual is intended for multiple product models, and the photos, illustrations, descriptions, etc, in this manual may be different from the actual appearances, functions, features, etc, of the product.
- This manual is intended for multiple software versions, and the illustrations and descriptions in this manual may be different from the actual GUI and functions of the software.
- Despite our best efforts, technical or typographical errors may exist in this manual. Uniview cannot be held responsible for any such errors and reserves the right to change the manual without prior notice.
- Users are fully responsible for the damages and losses that arise due to improper operation.
- Uniview reserves the right to change any information in this manual without any prior notice or indication. Due to such reasons as product version upgrade or regulatory requirement of relevant regions, this manual will be periodically updated.

Disclaimer of Liability

- To the extent allowed by applicable law, in no event will Uniview be liable for any special, incidental, indirect, consequential damages, nor for any loss of profits, data, and documents.
- The product described in this manual is provided on an "as is" basis. Unless required by applicable law, this manual is only for informational purpose, and all statements, information, and recommendations in this manual are presented without warranty of any kind, expressed or implied, including, but not limited to, merchantability, satisfaction with quality, fitness for a particular purpose, and noninfringement.
- Users must assume total responsibility and all risks for connecting the product to the Internet, including, but not limited to, network attack, hacking, and virus. Uniview strongly recommends that users take all necessary measures to enhance the protection of network, device, data and personal information. Uniview disclaims any liability related thereto but will readily provide necessary security related support.
- To the extent not prohibited by applicable law, in no event will Uniview and its employees, licensors, subsidiary, affiliates be liable for results arising out of using or inability to use the product or service, including, not limited to, loss of profits and any other commercial damages or losses, loss of data, procurement of substitute goods or services; property damage, personal injury, business interruption, loss of business information, or any special, direct, indirect, incidental, consequential, pecuniary, coverage, exemplary, subsidiary losses, however caused and on any theory of liability, whether in contract, strict liability or tort (including negligence or otherwise) in any way out of the use of the product, even if Uniview has been advised of the possibility of such damages (other than as may be required by applicable law in cases involving personal injury, incidental or subsidiary damage).
- To the extent allowed by applicable law, in no event shall Uniview's total liability to you for all damages for the product described in this manual (other than as may be required by applicable law in cases involving personal injury) exceed the amount of money that you have paid for the product.

Network Security

Please take all necessary measures to enhance network security for your device.

The following are necessary measures for the network security of your device:

- **Change default password and set strong password:** You are strongly recommended to change the default password after your first login and set a strong password of at least nine characters including all three elements: digits, letters and special characters.
- **Keep firmware up to date:** It is recommended that your device is always upgraded to the latest version for the latest functions and better security. Visit Uniview's official website or contact your local dealer for the latest firmware.

The following are recommendations for enhancing network security of your device:

- **Change password regularly:** Change your device password on a regular basis and keep the password safe. Make sure only the authorized user can log in to the device.
- **Enable HTTPS/SSL:** Use SSL certificate to encrypt HTTP communications and ensure data security.
- **Enable IP address filtering:** Allow access only from the specified IP addresses.
- **Minimum port mapping:** Configure your router or firewall to open a minimum set of ports to the WAN and keep only the necessary port mappings. Never set the device as the DMZ host or configure a full cone NAT.
- **Disable the automatic login and save password features:** If multiple users have access to your computer, it is recommended that you disable these features to prevent unauthorized access.
- **Choose username and password discretely:** Avoid using the username and password of your social media, bank, email account, etc, as the username and password of your device, in case your social media, bank and email account information is leaked.
- **Restrict user permissions:** If more than one user needs access to your system, make sure each user is granted only the necessary permissions.
- **Disable UPnP:** When UPnP is enabled, the router will automatically map internal ports, and the system will automatically forward port data, which results in the risks of data leakage. Therefore, it is recommended to disable UPnP if HTTP and TCP port mapping have been enabled manually on your router.
- **SNMP:** Disable SNMP if you do not use it. If you do use it, then SNMPv3 is recommended.
- **Multicast:** Multicast is intended to transmit video to multiple devices. If you do not use this function, it is recommended you disable multicast on your network.
- **Check logs:** Check your device logs regularly to detect unauthorized access or abnormal operations.
- **Physical protection:** Keep the device in a locked room or cabinet to prevent unauthorized physical access.
- **Isolate video surveillance network:** Isolating your video surveillance network with other service networks helps prevent unauthorized access to devices in your security system from other service networks.

Learn More

You may also obtain security information under Security Response Center at Uniview's official website.

Safety Warnings

The device must be installed, serviced and maintained by a trained professional with necessary safety knowledge and skills. Before you start using the device, please read through this guide carefully and make sure all applicable requirements are met to avoid danger and loss of property.

Storage, Transportation, and Use

- Store or use the device in a proper environment that meets environmental requirements, including and not limited to, temperature, humidity, dust, corrosive gases, electromagnetic radiation, etc.
- Make sure the device is securely installed or placed on a flat surface to prevent falling.
- Unless otherwise specified, do not stack devices.
- Ensure good ventilation in the operating environment. Do not cover the vents on the device. Allow adequate space for ventilation.
- Protect the device from liquid of any kind.
- Make sure the power supply provides a stable voltage that meets the power requirements of the device. Make sure the power supply's output power exceeds the total maximum power of all the connected devices.
- Verify that the device is properly installed before connecting it to power.
- Do not remove the seal from the device body without consulting Uniview first. Do not attempt to service the product yourself. Contact a trained professional for maintenance.
- Always disconnect the device from power before attempting to move the device.
- Take proper waterproof measures in accordance with requirements before using the device outdoors.

Power Requirements

- Install and use the device in strict accordance with your local electrical safety regulations.
- Use a UL certified power supply that meets LPS requirements if an adapter is used.
- Use the recommended cordset (power cord) in accordance with the specified ratings.
- Only use the power adapter supplied with your device.
- Use a mains socket outlet with a protective earthing (grounding) connection.
- Ground your device properly if the device is intended to be grounded.

Contents

1 Introduction	1
2 Device Installation	1
2.1 Install Video Wall	1
2.2 Connect Cables	1
2.2.1 Cable Description	2
2.2.2 Cable Connection	2
3 Device Introduction	3
3.1 Video Display	3
3.2 Remote Control	4
4 Device Configuration	5
4.1 Set Splicing Screen ID	5
4.2 Control Single Splicing Screen	6
4.3 Switch Video Source	6
4.4 Other Settings	6
4.4.1 Image	7
4.4.2 Option	7
4.4.3 Splice Screens	8
4.4.4 Advanced	10

1 Introduction

The LCD splicing display unit (hereinafter referred to as "splicing screen") adopts industrial-grade panel and highly reliable integrated design. It has various video input and output interfaces and business functions, used in industries such as emergency command center, video surveillance, media and entertainment, etc.

This manual mainly introduces the wiring and screen operations of the splicing screen, so as to help you understand how to configure and use the product.

**NOTE!**

The interface and function operations may vary with device model.

2 Device Installation

2.1 Install Video Wall

Each splicing screen can serve as an independent display device. You can also splice multiple screens into a video wall as needed.

See the splicing screen installation guide for detailed installation steps. The following takes the video wall installation as an example.

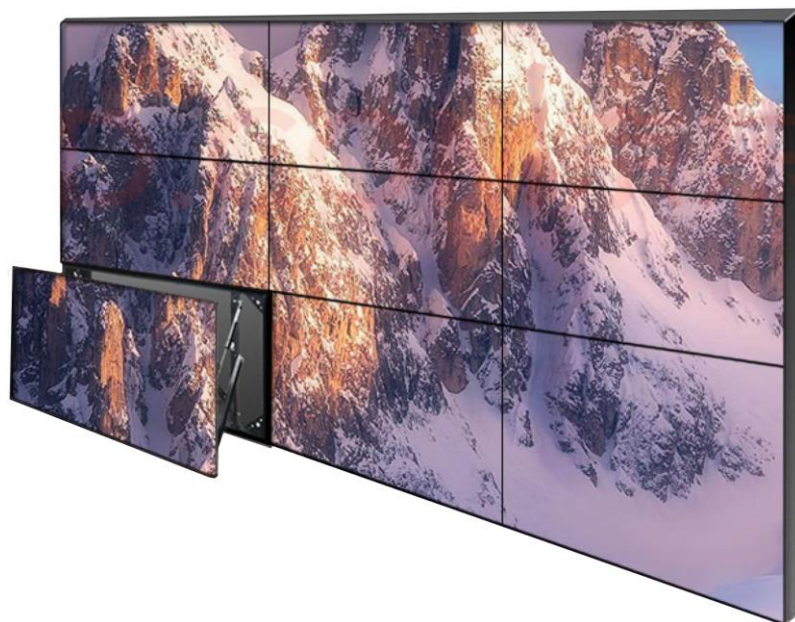

2.2 Connect Cables

If you only want to view the live video on the video wall, connect the power cable and video cable. If you want to control the video wall with the remote control, connect the power cable, video cable, control cable, and infrared receiver cable.

For the interface description of the splicing screen, see the quick guide shipped with the product. The following briefly introduces the cable connection among splicing screens.

2.2.1 Cable Description

1. RS232 Serial Cable

The RS232 interface is an RJ45 connector. It must be connected with a straight-through network cable instead of a crossover network cable.

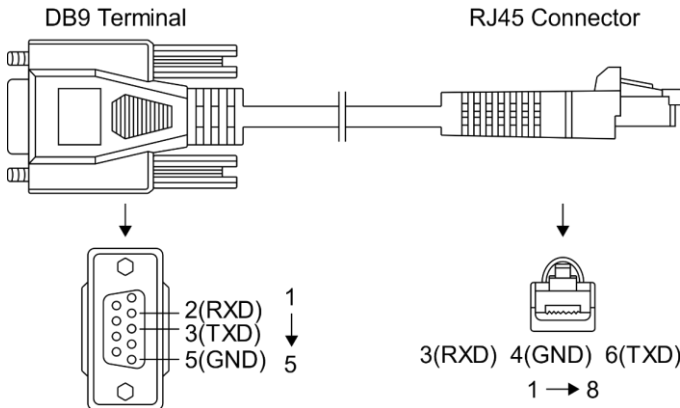

DB9 Pin No.	DB9 Terminal	RJ45 Wiring Order	RJ45 Connector	Description
2	RXD	3	RXD	Receive
3	TXD	6	TXD	Transmit
5	GND	4	GND	Ground

2. Infrared Receiver Cable



2.2.2 Cable Connection

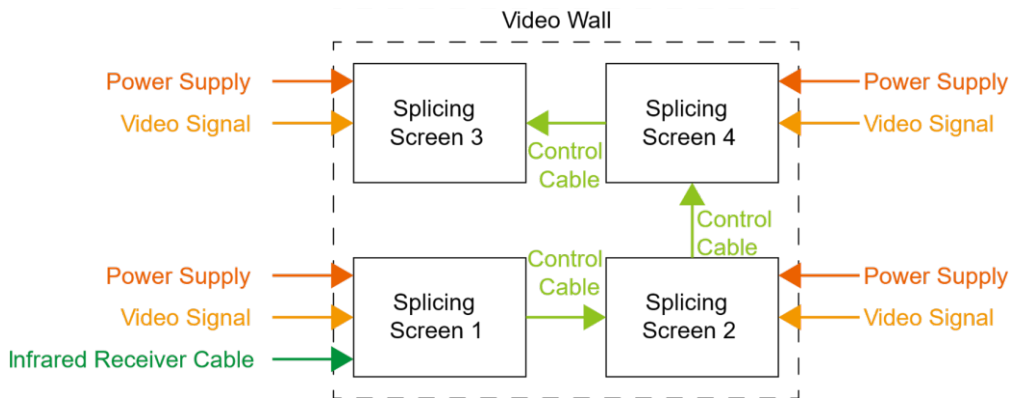

Cable	Description
Power Cable	Connects the splicing screen to the power via the power interface for power input. After the splicing screen is powered on, turn on the power switch to start the splicing screen.

Cable	Description
Video Cable	Connects the video signal source to the HDMI input or VGA input interface of a splicing screen for video signal input.
Control Cable	Connects all splicing screens via the RS232 input and RS232 output interfaces for series connection. If the control signal is input from the first splicing screen, the video wall can be controlled uniformly.
Infrared Receiver Cable	Connects the infrared input interface of the first splicing screen to receive the control signal from the remote control, and then the video wall can be controlled with the remote control.

If the video interface supports the loop output, input the video signal to a splicing screen, and the video signal can be looped out to the next splicing screen through the loop out interface. Connect multiple splicing screens via the video loop out interface, and these splicing screen can share the same video source.



NOTE!

The number of video loop connections may vary with the bandwidth of the input video source. The maximum number of video loop connections is 9 for the 4K video source and 24 for the 2K video source.

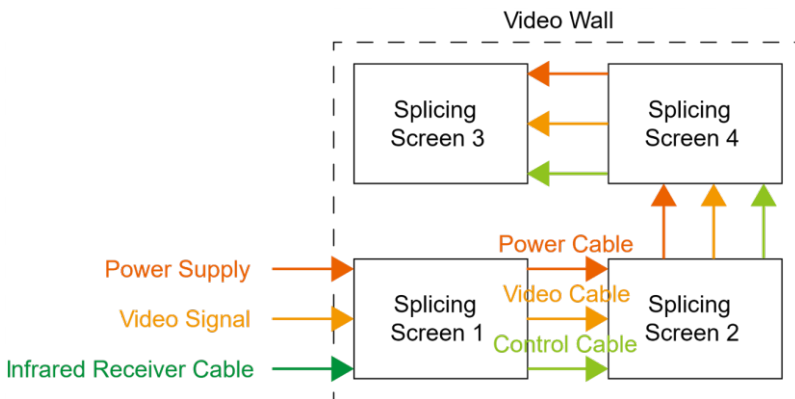

3 Device Introduction

3.1 Video Display

The video wall can display the video of video source from the USB interface, or HDMI/VGA input interface, etc.

- Video input interface

- Display directly: Connect the splicing screen to the video sources such as IPC, PC, etc., and the corresponding video will be displayed directly on the splicing screen.

If a splicing screen is connected to multiple video sources at the same time, you can switch the video displayed on the splicing screen using the remote control.

- Display after decoding: Connect the splicing screen to the decoder, and the videos from video sources such as IPC and PC will be displayed on the splicing screen after being decoded by the decoder.

- USB interface
 - (1) Connect the USB flash driver to the USB interface of the splicing screen.
 - (2) Control the splicing screen with the remote control, and switch to the USB video source. See [Device Configuration](#) for details.
 - (3) Select an image/video, and tap **ENTER** to play the selected image/video on the splicing screen.
 - (4) Press to switch other images/videos.



NOTE!

If **Auto Play** in **MENU > ADVANCED** is enabled, the images and videos of the USB flash driver can automatically recognized and played on the splicing screen.

3.2 Remote Control

After the video wall starts up, you can control a single splicing screen or the video wall using the remote control.

Make sure that the battery is properly installed in the remote control and that the battery is sufficient before use. Align the infrared transmitter on the top of the remote control with the infrared receiver cable connected to the video wall, and then press the buttons on the remote control to control the video wall.



NOTE!

The buttons not shown in the table below are reserved functions and are currently unavailable.

Button	Description	Diagram
	Turn on/off the device. Note: After you turn off the video wall using the remote control, the video wall remains powered on. Please be aware of fire and electric hazards.	
Signal source	Switch the video source.	
	<ul style="list-style-type: none"> ● Pause/resume video from the USB flash driver. ● Set the splicing screen ID. 	
	Stop video from the USB flash driver and exit the screen.	
CT	Adjust the color temperature of the screen.	
	<ul style="list-style-type: none"> ● Select the direction. ● Change values. 	
ENTER	Confirm the selection.	
MENU	<ul style="list-style-type: none"> ● Menu not open: Open the menu. ● Menu open: Return to the previous screen. 	
ESC	Exit the menu.	
FRZ	Pause/resume video on the video wall. Note: When you pause video on the video wall, the video source still plays the video; when you resume video, the video wall shows the current video of the video source.	

Button	Description	Diagram
INFO	Show the current video source information.	
0-9	Select the number.	
SEL	Select the splicing screen you want to control.	

4 Device Configuration

4.1 Set Splicing Screen ID

Set the ID for each splicing screen to control the single splicing screen.

1. Press **ID SET**, and each splicing screen shows a five-digit random code. To select a splicing screen, press the corresponding digit buttons of the random code.

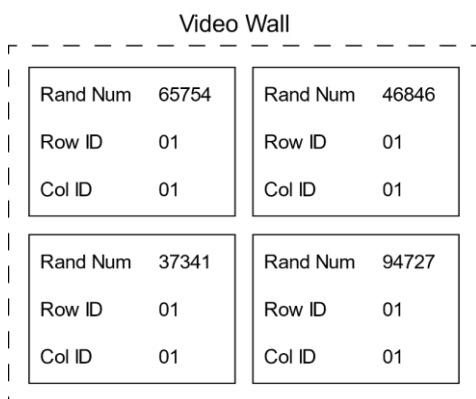

2. Tap to choose the row ID or column ID item.
3. Press to adjust the ID according to the actual row/column location of the splicing screen on the video wall.

The splicing screen ID consists of the row ID and column ID. The ID of each splicing screen must be unique. For example, if a splicing screen is located at the first row (01) and the second column (02), and then its screen ID is 0102.

4. Press **ENTER** to save the ID settings.
5. Follow the steps above to set the ID for all splicing screens.

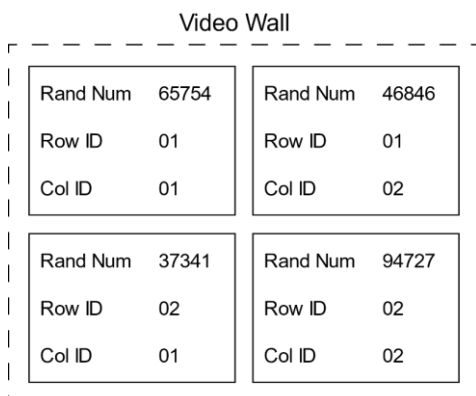

4.2 Control Single Splicing Screen

The remote control controls the video wall by default. You can also select a single splicing screen by the corresponding ID, and then the remote control operation only take effect on the selected single splicing screen, and only the **ID SET** and **SEL** buttons are available to other splicing screens.

1. Press **SEL**, and each splicing screen shows the corresponding ID.

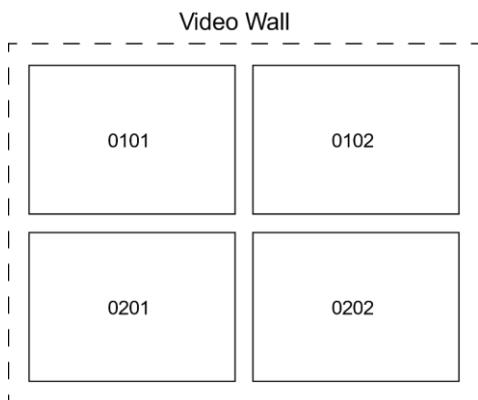

2. Press the digit buttons corresponds to the ID to select the splicing screen, and then you can control the screen with the remote control, such as, switching video sources, pausing video, etc.

When the single splicing screen is controlled, press **SEL** can switch to the video wall control mode, and press **ESC** to perform other operations on the video wall.

4.3 Switch Video Source

The video of the HDMI signal source is displayed on the video wall by default. When there is no HDMI signal input, the video wall shows a prompt, **No Signal**, and you can switch to other video sources as needed.

1. Press , and the **Input Source** screen appears.

Input Source
Component
PC-RGB
HDMI
DP
DVI
AV
USB
⊙ OK

2. Press  to select the upper/lower signal source.
3. Press **ENTER** to play the corresponding video.

4.4 Other Settings

Press **MENU** to open the menu screen and set other parameters for the video wall.

Press \leftarrow \rightarrow to move the menu tab left/right; press \wedge \vee to mode the option up/down; press **ENTER** to confirm the selection.

4.4.1 Image

Set the image display effect.

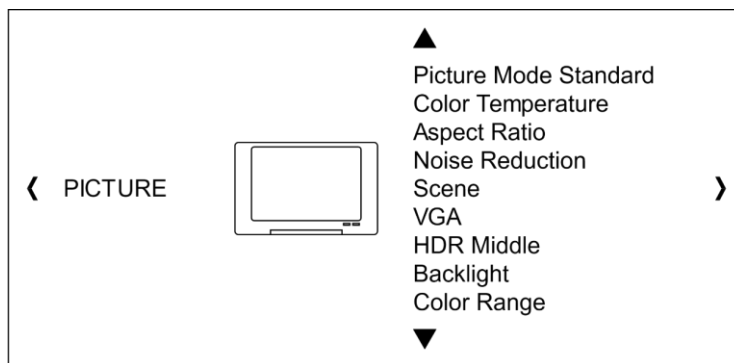

Item	Description
Picture Mode	The image display mode. If the mode is set to User , the parameter values can be customized.
Color Temperature	The warm and cold effect of the image. If the mode is set to User , the parameter values can be customized.
Aspect Ratio	Set the image aspect ratio for each splicing screen according to the resolution and ratio of the video source. <ul style="list-style-type: none"> ● 4:3/16:9: Display video in uniform scale when the video source and splicing screen have the same aspect ratio but different resolutions. ● Point to Point: Display point-to-point video when the resolution of the video source is the same as that of the splicing screen. If the aspect ratio of the splicing screen does not match with that of the video source, the video displayed on the splicing screen will be scaled and distorted.
Noise Reduction	Reduce the noise for a clear and smooth image.
Scene	Set the image display scene according to the actual application scene.
VGA Screen	Set the image display effect of the VGA signal on the video wall. <ul style="list-style-type: none"> ● Automatic adjustment: Adaptively adjust the image display effect. ● Horizontal +/-: Move the image left/right. ● Vertical +/-: Move the image up/down. ● Clock: Adjust the image refresh frequency. ● Phase: Adjust the image offset value.
HDR	High-dynamic-range rendering, used to increase the image brightness and contrast to deliver more image details.
Backlight	The backlight brightness of the video wall, used to change the image brightness.
Color Range	The color range of the image. The larger the range, the more colorful the image.

4.4.2 Option

Set the system parameters and upgrade the splicing screen version.

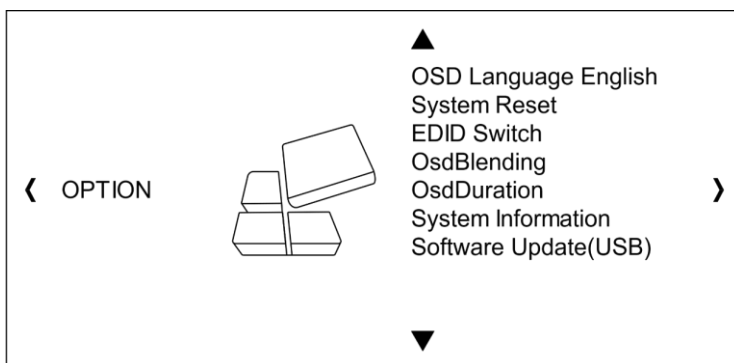

Item	Description
OSD Language	The screen language.
System Reset	Restore the default settings and restart the screen.
EDID Switch	EDID represents the capabilities and characteristics of the splicing screen. The video source can read the EDID information and select the most suitable settings for the splicing screen to provide the best display effect.
OSD Blending	The transparency of the menu screen.
OSD Duration	The display duration of the menu screen. If there is no operation after the set time, the menu screen will exit automatically.
System Information	View the system information.
Software Update (USB)	<p>Upgrade a single splicing screen through a USB flash driver. Support upgrade when the splicing screen is turned on or turned off. If you want to upgrade multiple splicing screens, it is required to upgrade them one by one.</p> <ul style="list-style-type: none"> ● Upgrade when the splicing screen starts up <ol style="list-style-type: none"> (1) Save the file in the .bin format to the root directory of the USB flash driver, and connect the USB flash driver to the USB port of the splicing screen when the splicing screen is turned on. (2) Select the splicing screen with the remote control, go to MENU > OPTION > Software Update(USB), and then the system will automatically detect the upgrade file of the USB flash driver. Press ENTER to upgrade the screen. ● Upgrade when the splicing shuts down <ol style="list-style-type: none"> (1) Save the file in the .bin format to the root directory of the USB flash driver, and connect the USB flash driver to the USB port of the splicing screen when the splicing screen is turned off. (2) Turn on the splicing screen, and the system will automatically detect the upgrade file of the USB flash driver and upgrade the screen. <p>Note:</p> <ul style="list-style-type: none"> ● Please do not disconnect the splicing screen from the power during upgrade, otherwise the screen may be damaged. ● If the upgrade fails, check whether the files in the .bin format are saved in the USB flash driver, and whether the USB flash driver is correctly connected to the splicing screen.

4.4.3 Splice Screens

Splice multiple adjacent splicing screens on the video wall to display one image of the video source.

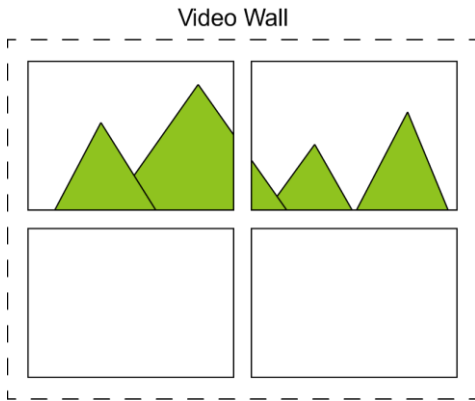

1. Connect to the Same Video Source

Divide a video source into multiple channels of video through the splitter and input these video signals to multiple adjacent splicing screens, and then the same video source can be displayed in multiple splicing screens simultaneously.

If the video interface of the splicing screen supports the loop output, the same video source can be output to multiple splicing screens via the loop output interfaces instead of the splitter.

2. Set Splicing Parameters

Select a splicing screen by inputting the screen ID, go to **MENU > SPLICE**, and set its splicing parameters. Follow the above steps to set the splicing parameters of other adjacent splicing screens, and then the adjacent splicing screens that finish the splicing settings will be automatically spliced and display one image of the video source.

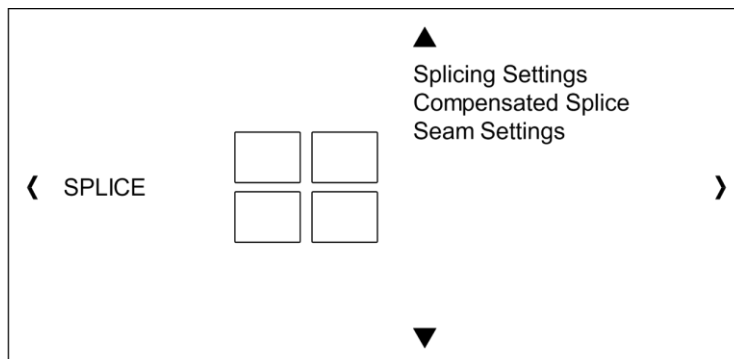

Splicing Settings

Set the splicing parameters of splicing screens, that is, the locations of splicing screens on the video wall.

Item	Description
Monitor ID	Display the splicing screen ID.
Hor/Ver Position	The row/column order of the splicing screen on the video wall. Note: Please set the horizontal/vertical size first.
Hor/Ver Size	Total number of rows/columns on the video wall.
Power On Delay	Delay time to turn on the splicing screens. Avoid the instantaneous excessive current and impact on the video wall caused by turning on splicing screens at the same time.

Item	Description
Power On Orderly	<p>Power on the splicing screens in the order of the row/column position of the splicing screen ID, that is, the system will turn on the splicing screens in order, then turn on the splicing screens in the second row in order, from the first row to the last row.</p> <p>Note: If power on delay has been set for a screen, the screen will power on until the set delay time is over.</p>

To cancel the splicing, set the **Hor/Ver Position** and **Hor/Ver Size** to 1.

Seam Settings/Compensated Splice

Set the seam compensation parameters to eliminate image misalignment caused by the seams between screens, improving the splicing effect.

Item	Description	
Seam Settings	Seam Switch	Enable/disable the seam settings.
	Hor Seam	Move the image right horizontally.
	Ver Seam	Move the image down vertically.
Compensated Splice	Adjust the compensation splice automatically.	

4.4.4 Advanced

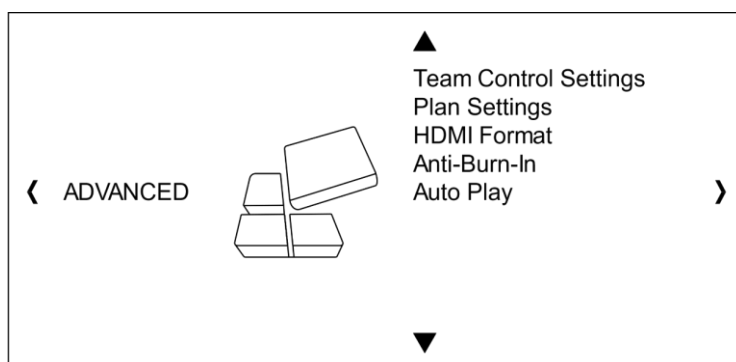

Item	Description	
Temp Control Settings	System Temp	Show the current temperature of the splicing screen.
	Fan Set	<p>Control the fan status to adjust the temperature of the splicing screen.</p> <ul style="list-style-type: none"> ● Manual: Tap On/Off to enable/disable the fan manually. ● Auto control: Tap Auto to turn on/off the fan automatically. The fan turns on when the splicing screen temperature is higher than 46°C and turns off when the temperature is lower than 38°C. <p>Note: The fan settings is unavailable if the splicing screen is fanless.</p>
	Temp Alarm/Alarm Action	<p>Set temperature alarm threshold (60°C to 70°C is recommended) and alarm action. If the temperature of splicing screen exceeds the threshold:</p> <ul style="list-style-type: none"> ● No Action: The high temperature alarm will be closed. ● Notice: A pop-up window will be displayed to prompt the high temperature. ● Notice and Power Off: A pop-up window will be displayed to prompt the high temperature and the splicing screen will be turned off after 180 seconds, which can avoid the damage of splicing screen caused by long-term high temperature.

Item	Description
Plan Settings	Reserved.
HDMI Format	Show the video format of the HDMI signal source.
Anti-Burn-In	Prevent screen burns and damage caused by prolonged display of a fixed image.
Auto Play	If you connect a USB flash driver to the splicing screen and switch the video source to USB, the images and videos in the USB flash driver will be automatically recognized and played.